



Phantom[®] XL





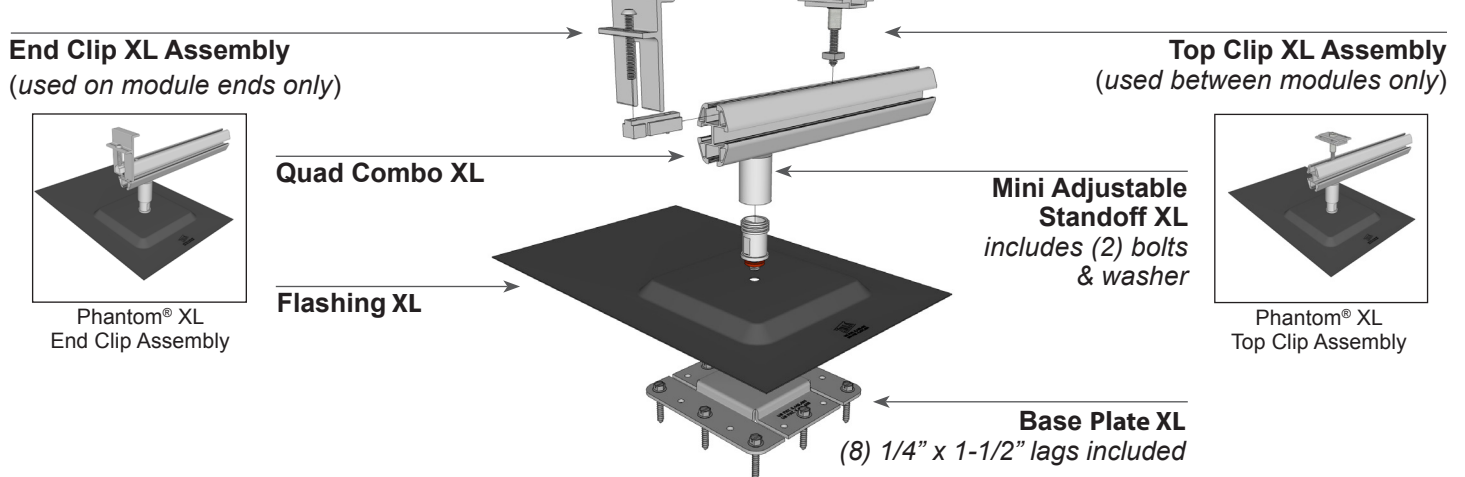

Technical Specifications

One or more patents apply to this product including without limitation: US Pat. 8,448,405; 8,479,455; 8,707,654; 8,689,517; 8,707,655; 8,833,032; 8,833,033; and/or 8,752,338.

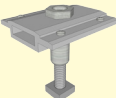
Phantom[®] XL Assembly

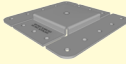

Phantom[®] XL is available in Mill and Black and includes: Base Plate XL, 8 lags, Flashing XL, Mini Adjustable Standoff XL, washer, Quad Combo XL, End Clip XL Assembly, Top Clip XL Assembly and necessary hardware.

| PRODUCT | DESCRIPTION | MATERIALS | SIZE | COLOR |
|---|---|------------------|---|---------------|
|  End Clip XL Assembly | Clip assembly used to secure modules at the end of an array or individually on both sides. 1/4"-20 SS bolt, set screw included. | Aluminum | 2" L x 2" W x 3-1/8" H | Mill Black |
|  Top Clip XL Assembly | Clip assembly used to secure two modules to the Quad Combo XL in the middle of an array. 5/16"-18 SS set bolt and square nut included. | Aluminum | 2" L x 1-3/4" W x 2-7/8" H | Mill Black |
|  Quad Combo XL | Zilla [®] Quad Combo rail section acts as support and attachment point for modules. Connects between Mini Standoff and End/Top Clip. | Aluminum | 6" L x 1-1/2" W x 2" H | Mill |
|  Mini Adjustable Standoff XL | Provides vertical adjustment between Flashing and Quad Combo XL. 3/8"-16 SS hardware and encapsulated gland washer included. | Aluminum | Ø1.375" x 1.75" - 2.75" (~1" adjustment) | Mill |
|  Flashing XL (not used for metal roofs) | Sits on top of the Base Plate XL, and is captured by the Mini Standoff. 26 ga. | Aluminum | 15" L x 9-7/8" W x 1/2" H | Mill Black |
|  Base Plate XL | Base Plate is attached to the roof with lags. Flashing is attached to the Base Plate using the Mini Standoff. | Galvanized Steel | 6" L x 6" W x 1/2" H | Mill |
|  Lags (eight included) | 1/4" x 1-1/2" lags. Eight (8) included. | Zinc | 3/8" hex drive | Zinc |

Zilla[®] So Simple It's ScarySM

77 Waneka Pkwy • Lafayette • CO 80026 • 720.880.6700 • fax 303.655.0379 • zillarac.com

 MADE IN USA  MADE WITH RECYCLED MATERIAL © 2013 Zilla Corporation. All rights reserved.